

**Title:**

# A Luminaire

**Phil. Industrial Design Registration Number:**

3-2006-000623

**Designer:**

Gene H. Chua  
Of Mandaue City, Cebu, Philippines

**Applicant:**

Simoncrafts International, Inc.  
Of Mandaue City, Cebu, Philippines

**Filing Date:**

17 August 2006

**Issue Date:**

26 November 2007

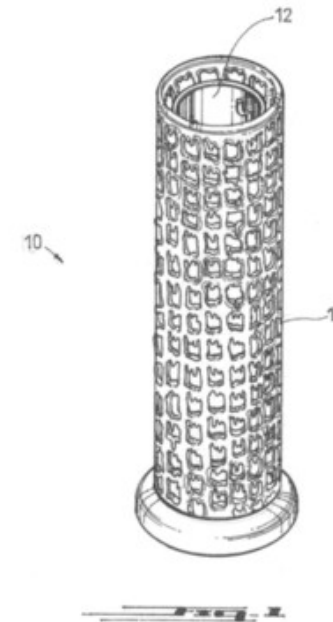

**Title:**

# An Upstanding Display Article

**Phil. Industrial Design Registration Number:**

3-2004-000316

**Designer:**

Rosemarie Pono  
Of Mandaue City, Cebu, Philippines

**Applicant:**

Tambuli Fashion and Home Accessories, Inc.  
Of Mandaue City, Cebu, Philippines

**Filing Date:**

28 May 2004

**Issue Date:**

19 May 2005

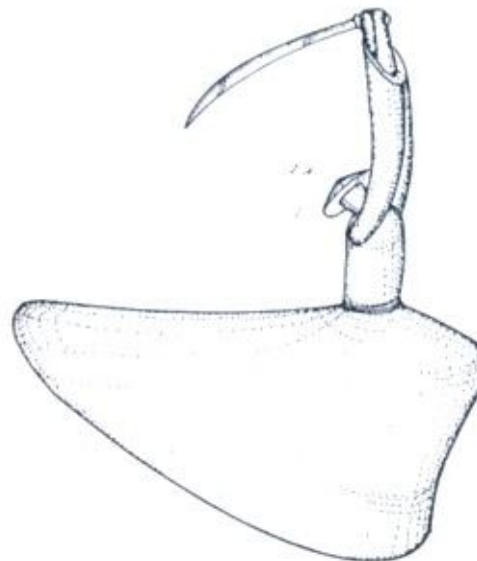

FIG. 1

**Title:**

# Beach Chair

**Phil. Industrial Design Registration Number:**

3-2003-000854

**Designer:**

Richard Frinier  
Of Luneburg, Germany

**Applicant:**

DEDON GmbH  
Of Luneburg, Germany

**Filing Date:**

05 December 2003

**Issue Date:**

29 July 2005



**Title:**

# Dual Pattern Basketball

**Phil. Industrial Design Registration Number:**

3-2005-001006

**Designer:**

Andrew G. Choachuy  
Of Mandaue City, Cebu, Philippines

**Applicant:**

Onitsuka Multi-Products, Inc.  
Of Mandaue City, Cebu, Philippines

**Filing Date:**

07 October 2005

**Issue Date:**

15 January 2007

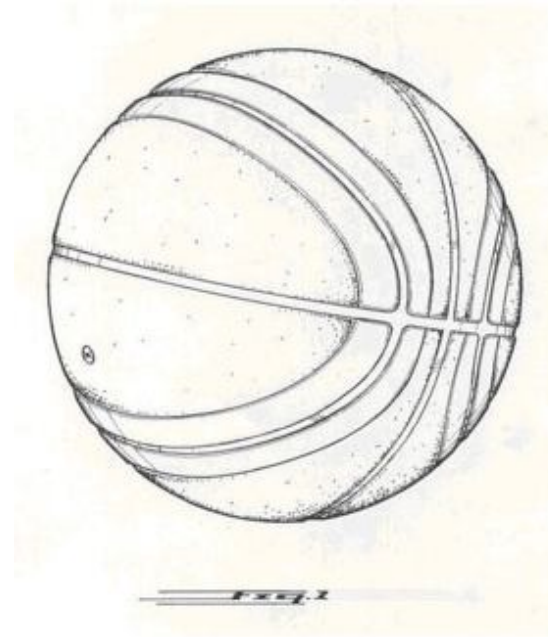

**Title:**

# Head For Golfclub

**Phil. Industrial Design Registration Number:**

3-2006-000044

**Designer:**

Kim Youn Sick  
Of Seoul, Korea

**Applicant:**

Kim Youn Sick  
Of Seoul, Korea

**Filing Date:**

03 February 2006

**Issue Date:**

05 February 2007

**Foreign Application Priority Data**

**Number:**

30-2005-002647

**Date:**

05 August 2005

**Country:**

Korea

**International Class:**

D21-02

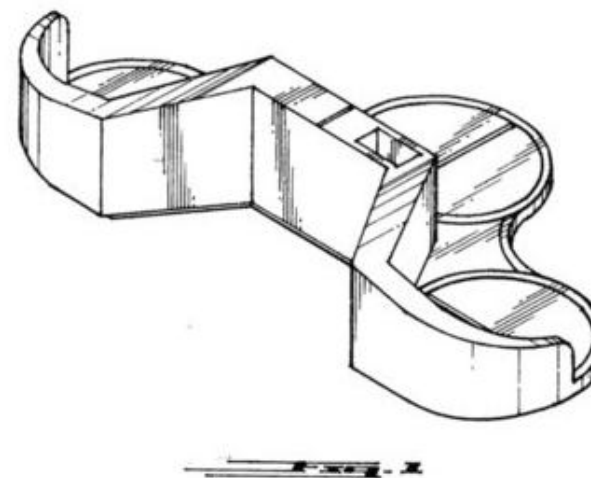

**Title:**

# A Seat with an Adjustable Canopy

**Philippine Patent Number:**

1-2003-000554

**Inventor:**

Richard Frinier  
Of Luneburg, Germany

**Applicant:**

DEDON GmbH  
Of Luneburg, Germany

**Filing Date:**

05 December 2003

**Issue Date:**

09 November 2007

**Claim:**

1. A seat comprising a seat body having a backrest, a seat rest, a leg portion extending to a base portion and a canopy being secured on top of said seat body, characterized in that said seat body being provided with an adjusting means to allow said canopy to be adjusted in a collapsible manner, and said means being provided with a locking element to selectively interlock said canopy in substantially collapsed and uncollapsed configuration with respect to said seat rest and the upper edge of said backrest.

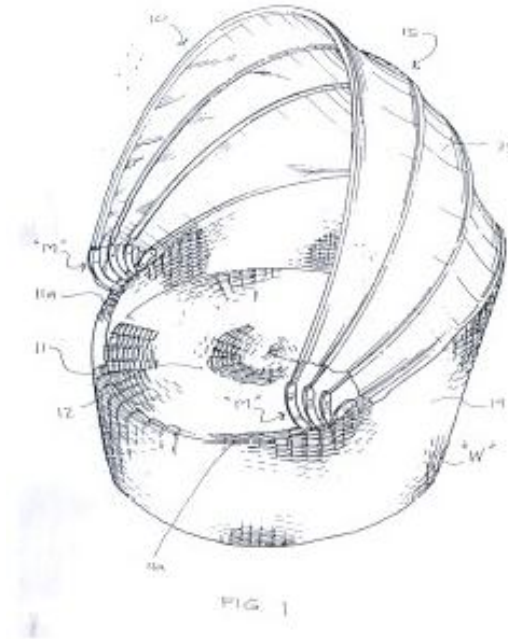

**Title:**

# An Improved Sock

**Utility Model Registration Number:**

2-2005-000204

**Maker:**

Tan Kian Go  
Of Valenzuela City, Philippines

**Applicant:**

Tan Kian Go  
Of Valenzuela City, Philippines

**Filing Date:**

10 May 2005

**Issue Date:**

04 December 2006

**Claim:**

An improved sock comprising a sock body having a sole region, an ankle, heel and toe portions, and at least one elastic portion being formed thereon, characterized in said sock body being defined by an upper portion and a lower thickened portion formed on the sole region extending from the ankle and heel portions and up to the toe portion thereof, said upper portion being formed by a thin terry and said lower thickened portion being formed by a substantially dense terry.

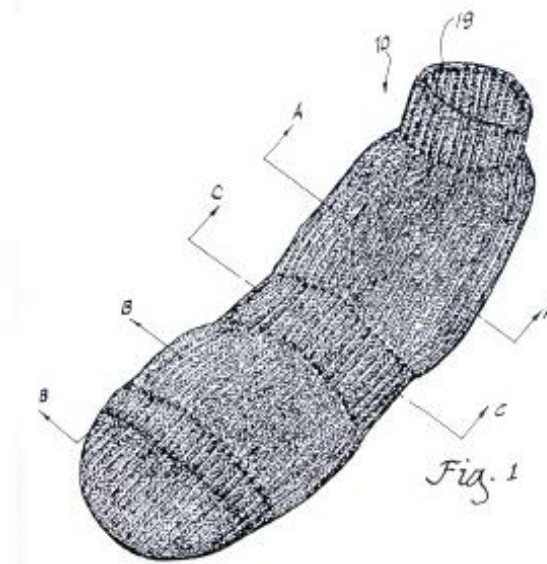

**Title:**

# An Improved Upstanding Display Article

**Utility Model Registration Number:**

2-2005-000454

**Maker:**

Grace Montebon  
Of Mandaue City, Cebu, Philippines

**Applicant:**

Tambuli Fashion and Home Accessories, Inc.  
Of Mandaue City, Cebu, Philippines

**Filing Date:**

21 October 2005

**Issue Date:**

12 February 2007

**Claim:**

An improved upstanding display article comprising a main stonecast body defined by an ornate figure having at least one metal component to accentuate or complete the desired form of said ornate figure, characterized in that an auxiliary body is provided and secured to said main body.

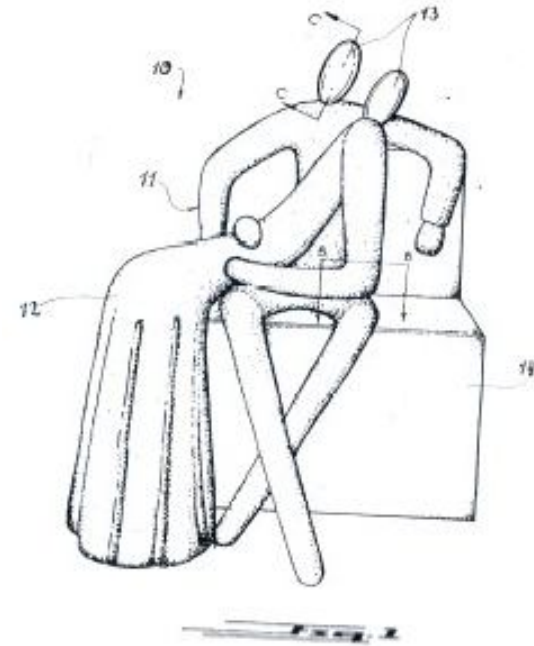



**Title:**  
**An Improved Water Storage Tank**

**Utility Model Registration Number:**  
2-2002-000525

**Maker:**  
Pacita U. Tseng  
Of Lahug, Cebu City, Philippines

**Applicant:**  
Granite Industrial Corporation  
Of Lahug, Cebu City, Philippines

**Filing Date:**  
04 December 2002

**Issue Date:**  
05 July 2004

**Claim:**

An improved water storage tank comprising: a generally cylindrical tank body having a lower and upper open end portions, said lower open end portion having an outer peripheral flange, and said tank body being provided with a plurality of spaced apart circumferential ribs; a dome-shaped top wall fixedly secured on said upper open end portion, said top wall being provided with air and water inlets; a monolithic inverted dome-shaped bottom wall being provided with a corresponding outer peripheral flange, said corresponding outer peripheral flange being fixedly secured on said outer peripheral flange of the lower open end portion of said tank body to form a joint section thereon, said bottom wall being provided with corresponding air and water outlets; a ring gasket being provided on said joint section; and an associated tank stand.

